



# AEON™

## ENDOSCOPIC STAPLER INSTRUCTIONS FOR USE



⚠ Review the following information carefully before using the device.

Instructions for Use may also be found at [www.lexington-med.com/IFU](http://www.lexington-med.com/IFU)

NOTE: These Instructions for Use are designed to assist in the use of this product - they are not a reference for surgical techniques.



Lexington Medical, Inc.  
23 Crosby Drive  
Bedford, MA 01730 USA  
+1.617.209.9817

**Australian Sponsor:**

AA-Med Pty. Ltd.  
Suite 10.04, 1 Chandos Street,  
St Leonards NSW 2065, Australia  
Tel: 1300 887 807

©2024 LEXINGTON MEDICAL, INC. ALL RIGHTS RESERVED.  
Instructions for Use Label P/N 900368 Rev-T

# 1. INTRODUCTION

## 1.1. INDICATIONS FOR USE

The AEON™ Endoscopic Stapler has applications in general, abdominal, gynecologic, pediatric, and thoracic surgery for resection, transection, and creation of anastomoses. The instrument may be used for transection and resection of liver substance, hepatic vasculature, biliary structures, pancreas, kidney and spleen.

CAUTION: Federal law restricts this device to sale by or on the order of a physician.

## 1.2. CONTRAINDICATIONS

1. The AEON™ Endoscopic Stapler should not be used on tissue that is necrotic, friable or has altered integrity, e.g., ischemic or edematous tissue.
2. Do not use the AEON™ Endoscopic Stapler where hemostasis cannot be verified visually after application.
3. The AEON™ Endoscopic Stapler is contraindicated for use on the heart, central circulatory system, or central nervous system.

## 1.3. COMPATIBILITY INFORMATION

The AEON™ Endoscopic Stapler Handle is compatible with all AEON™ Endoscopic Stapler Reloads.

The AEON™ Endoscopic Stapler Reload 4.0mm/60mm is compatible with Gore® SeamGuard® Bioabsorbable Staple Line Reinforcement model 1BSGTRI60P and Gunze NEOVEIL™ Absorbable Polyglycolic Acid Felt model NV-ET-M60A-2.

The AEON™ Endoscopic Stapler Reload 5.0mm/60mm is compatible with Gore® SeamGuard® Bioabsorbable Staple Line Reinforcement model 1BSGTRI60B and Gunze NEOVEIL™ Absorbable Polyglycolic Acid Felt model NV-ET-M60E-2.

## 1.4. GENERAL WARNINGS

1. **Endoscopic procedures using this device should be performed only by physicians with adequate training in endoscopic surgical techniques.**
2. **Select a Stapler Reload with the appropriate staple size for the tissue thickness. If reinforcement is used, always include the combined thickness of both the tissue and the reinforcement material when choosing the proper Stapler Reload.**
3. **Inspect the tissue thickness before applying the stapler to the tissue. Tissue that is overly thick or thin may result in unacceptable staple formation.**
4. **The AEON™ Endoscopic Stapler Reload 2.0 mm staples should not be used to staple tissue that compresses to less than 0.75 mm in thickness, or tissue that does not comfortably compress to 0.75 mm.**
5. **The AEON™ Endoscopic Stapler Reload 2.5 mm staples should not be used to staple tissue that compresses to less than 1.0 mm in thickness, or tissue that does not comfortably compress to 1.0 mm.**
6. **The AEON™ Endoscopic Stapler Reload 3.25 mm staples should not be used to staple tissue that compresses to less than 1.5 mm in thickness, or tissue that does not comfortably compress to 1.5 mm.**

7. The AEON™ Endoscopic Stapler Reload 4.0 mm staples should not be used to staple tissue that compresses to less than 1.8 mm in thickness, or tissue that does not comfortably compress to 1.8 mm.
8. The AEON™ Endoscopic Stapler Reload 5.0 mm staples should not be used to staple tissue that compresses to less than 2.2 mm in thickness, or tissue that does not comfortably compress to 2.2 mm.
9. Avoid use of the stapler on the aorta.
10. Ensure tissue has not extended beyond the tissue stop proximally. Tissue forced into the instrument proximal to the tissue stop may be transected without stapling or result in stapler malfunction.
11. The stapler will cut and staple any tissue, vessel, or other structure included in the jaws. Visually inspect anatomic structures within the jaws prior to firing. Ensure that only structures intended to be cut and stapled are within the stapler jaws. Unintentional transection of tissue could lead to patient injury, illness, or death.
12. Ensure that no obstructions, such as clips, are incorporated into the stapler jaws before closing the jaws and firing. Applying staples over an obstruction may result in incomplete transection and/or incorrectly formed staples.
13. Ensure that the Stapler Reload is completely fired. Failure to completely fire the Stapler Reload will result in an incomplete cut and/or incomplete staple formation, which may result in inadequate hemostasis and/or leakage. However, if an unusually high firing force is experienced mid-firing, consider stopping the firing and retracting the Stapler Reload. An unusually high firing force could indicate that the tissue is overly thick or that an obstruction is within the jaws. This may be indicated by a snap or pop sound in the handle.
14. After firing the stapler, always inspect the staple line and the surrounding site for hemostasis or leakage. Minor bleeding or leakage may be controlled by electrocautery or manual sutures.
15. The AEON™ Endoscopic Stapler Handle is provided STERILE and intended for use in a SINGLE PROCEDURE ONLY. The AEON™ Endoscopic Stapler Reload is provided STERILE and intended for SINGLE USE ONLY. DISCARD AFTER USE. DO NOT REUSE. DO NOT RE-STERILIZE. DO NOT RE-PROCESS. Reuse, even after re-sterilization, may create a risk of contamination and lead to patient infection. Reuse, re-processing, or re-sterilization may compromise device integrity and could lead to patient injury, illness, or death.
16. Clamping and unclamping of delicate structures, such as venous structures and bile ducts, may result in damage to tissue irrespective of stapler firing.
17. Ensure that the Reloads are compatible with the stapler handle.
18. Stapling excessively calcified vascular pedicles may result in unacceptable staple formation, inadequate hemostasis, and/or leakage.
19. Where practical, proximal control of blood vessels is recommended prior to stapling, and surgeons should have methods of blood vessel control in place in the event of stapler failure.
20. There is a potential risk of increased leak rates when staple lines are crossed, even if there may be clinical circumstances where a surgeon deems it necessary or appropriate to do so.

## 1.5.GENERAL PRECAUTIONS

1. Preoperative radiotherapy may result in changes to tissue thickness or composition. Consideration should be given to any pre-surgical treatment in selection of staple size.
2. Ensure that provisions are made for proximal and distal control before using the stapler on major vessels.
3. If reinforcement is used, always include the combined thickness of both the tissue and the reinforcement material when choosing the proper Stapler Reload.
4. Do not exceed 25 firings for a single Stapler Handle during a single procedure. Exceeding the Stapler Handle firing limit may result in device malfunction.
5. Before loading a new reload, confirm the reload has not been previously used.

6. If clamping is difficult, reposition the reload and clamp on less tissue. Ensure that the proper reload selection has been made.
7. Do not use the AEON™ Endoscopic Stapler Handle or AEON™ Endoscopic Stapler Reloads after the expiration date or if the package is damaged. This may render the equipment inoperable or non-sterile.
8. Do not use the AEON™ Endoscopic Stapler Handle or AEON™ Endoscopic Stapler Reloads if they become damaged or unsterile.

## 1.6. MRI SAFETY INFORMATION

MRI Safety Information	
A person with the Lexington Medical AEON™ Endoscopic Stapler System may be safely scanned under the following conditions. Failure to follow these conditions may result in injury.	
Device Name	AEON™ Endoscopic Stapler System
Static Magnetic Field Strength (Bo)	1.5 T or 3.0 T
Maximum Spatial Field Gradient	40 T/m (4,000 gauss/cm)
RF Excitation	Circularly Polarized (CP)
RF Transmit Coil Type	There are no Transmit Coil restrictions
RF Receive Coil Type	Any
Operating Mode	Normal Operating Mode
Maximum Whole-Body SAR	2 W/kg (Normal Operating Mode)
Maximum Head SAR	3.2 W/kg (Normal Operating Mode)
Scan Duration	2 W/kg whole-body average SAR for 60 minutes of continuous RF (a sequence or back to back series/scan without breaks)
MR Image Artifact	The presence of this implant may produce an image artifact of up to 3.7 mm.

## 1.7. DEVICE DESCRIPTION

The AEON™ Endoscopic Stapler places two triple-staggered rows of titanium staples while simultaneously transecting between the two triple-staggered rows of staples.

The AEON™ Endoscopic Stapler Handles listed below in Table 1 are compatible with the AEON™ Endoscopic Stapler Reloads listed in Table 2.

These Instructions for Use pertain to the following products:

**Table 1. ENDOSCOPIC STAPLER HANDLES**

<b>PRODUCT CODE</b>	<b>SHAFT LENGTH</b>
<b>AESH060</b>	SHORT (60mm)
<b>AESH160</b>	MEDIUM (160mm)
<b>AESH260</b>	LONG (260mm)
<b>AETH060</b>	SHORT (60mm)
<b>AETH160</b>	MEDIUM (160mm)
<b>AETH260</b>	LONG (260mm)

**Table 2. ENDOSCOPIC STAPLER RELOADS**

<b>PRODUCT CODE</b>	<b>ANVIL TIP</b>	<b>OPEN STAPLE HEIGHT</b>	<b>STAPLE LINE LENGTH</b>	<b>CLOSED STAPLE HEIGHT</b>
<b>AESR30G</b>	Regular	2.0mm	30mm	0.75mm
<b>AESR45G</b>	Regular	2.0mm	45mm	0.75mm
<b>AESR60G</b>	Regular	2.0mm	60mm	0.75mm
<b>AESR30W</b>	Regular	2.5mm	30mm	1.0mm
<b>AESR45W</b>	Regular	2.5mm	45mm	1.0mm
<b>AESR60W</b>	Regular	2.5mm	60mm	1.0mm
<b>AESR30R</b>	Regular	3.25mm	30mm	1.5mm
<b>AESR45R</b>	Regular	3.25mm	45mm	1.5mm
<b>AESR60R</b>	Regular	3.25mm	60mm	1.5mm
<b>AESR30P</b>	Regular	4.0mm	30mm	1.8mm
<b>AESR45P</b>	Regular	4.0mm	45mm	1.8mm
<b>AESR60P</b>	Regular	4.0mm	60mm	1.8mm
<b>AESR45B</b>	Regular	5.0mm	45mm	2.2mm
<b>AESR60B</b>	Regular	5.0mm	60mm	2.2mm
<b>ASR30GC</b>	Curved	2.0mm	30mm	0.75mm
<b>AESC45G</b>	Curved	2.0mm	45mm	0.75mm
<b>ASR30WC</b>	Curved	2.5mm	30mm	1.0mm
<b>AESC45W</b>	Curved	2.5mm	45mm	1.0mm
<b>AESC60W</b>	Curved	2.5mm	60mm	1.0mm
<b>ASR30RC</b>	Curved	3.25mm	30mm	1.5mm
<b>AESC45R</b>	Curved	3.25mm	45mm	1.5mm
<b>AESC60R</b>	Curved	3.25mm	60mm	1.5mm
<b>ASR30PC</b>	Curved	4.0mm	30mm	1.8mm
<b>AESC45P</b>	Curved	4.0mm	45mm	1.8mm
<b>AESC60P</b>	Curved	4.0mm	60mm	1.8mm
<b>ASR45BC</b>	Curved	5.0mm	45mm	2.2mm
<b>ASR30GS</b>	Short	2.0mm	30mm	0.75mm
<b>ASR30WS</b>	Short	2.5mm	30mm	1.0mm
<b>ASR60WS</b>	Short	2.5mm	60mm	1.0mm
<b>ASR30RS</b>	Short	3.25mm	30mm	1.5mm
<b>ASR60RS</b>	Short	3.25mm	60mm	1.5mm

<b>ASR30PS</b>	Short	4.0mm	30mm	1.8mm
<b>ASR60PS</b>	Short	4.0mm	60mm	1.8mm

NOTE: When using the instrument with a 2.0mm, 2.5mm, 3.25mm, and 4.0mm reload, the instrument MUST be inserted into a 12mm trocar. When using the instrument with a 5.0mm/45mm or 5.0mm/60mm reload, the instrument MUST be inserted into a 15mm trocar. A smaller size trocar will not accept the 5.0mm/45mm or 5.0mm/60mm reload.

**Table 3. TYPES OF TISSUE ON WHICH RELOADS MAY BE USED**

<b>OPEN STAPLE HEIGHT</b>	<b>CLOSED STAPLE HEIGHT</b>	<b>TISSUE TYPES</b>
<b>2.0mm</b>	0.75mm	Very thin
<b>2.5mm</b>	1.0mm	Thin
<b>3.25mm</b>	1.5mm	Medium
<b>4.0mm</b>	1.8mm	Thick
<b>5.0mm</b>	2.2mm	Very thick

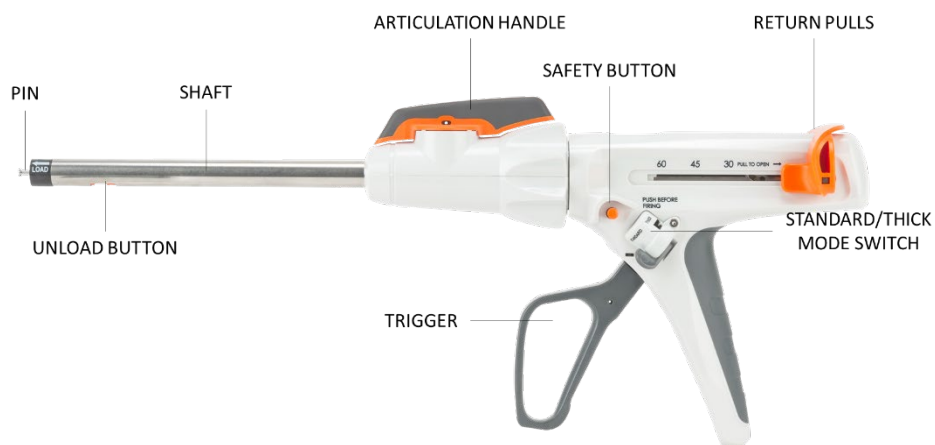

**Figure 1. STAPLER HANDLE SCHEMATIC**

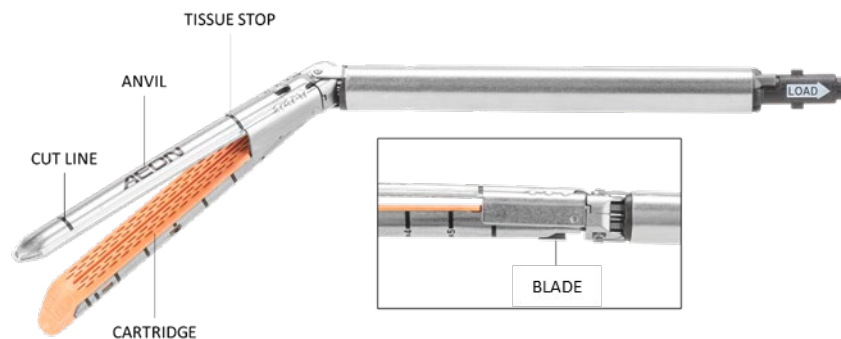

Figure 2. STAPLER RELOAD SCHEMATIC

The AEON™ Endoscopic Stapler Handle may be reloaded and fired up to 25 times in a single procedure.

## 2. INSTRUCTIONS FOR USE

### 2.1. LOADING INSTRUCTIONS

**WARNING:** Ensure that the reloads are compatible with the stapler handle.

**WARNING:** Select a Stapler Reload with the appropriate staple size for the tissue thickness. If reinforcement is used, always include the combined thickness of both the tissue and the reinforcement material when choosing the proper Stapler Reload.

**CAUTION:** Before loading a new reload, confirm the reload has not been previously used.

**CAUTION:** Do not use the AEON™ Endoscopic Stapler Handle or AEON™ Endoscopic Stapler Reloads if they become damaged or unsterile.

**NOTE:** When using the instrument with a 2.0mm, 2.5mm, 3.25mm, and 4.0mm reload, the instrument MUST be inserted into a 12mm trocar. When using the instrument with a 5.0mm/45mm or 5.0mm/60mm reload, the instrument MUST be inserted into a 15mm trocar. A smaller size trocar will not accept the 5.0mm/45mm or 5.0mm/60mm reload.

**NOTE:** Do not attempt to remove the yellow/orange shipping wedge from the Stapler Reload until after the Stapler Reload is loaded onto the Stapler Handle. Removing the shipping wedge from the Stapler Reload before the Stapler Reload is loaded onto the Stapler Handle may cause device malfunction.

1. Check reload and handle expiration date and confirm that the product is not expired.
2. Visually inspect reload and handle packaging for damage.
3. The Stapler Reload is packaged in the open position – do not attempt to close the Stapler Reload jaws.

4. Ensure that the return pulls on the device are fully retracted to the proximal position and that the articulation handle is centered on the device.
5. To load the Stapler Reload, first align the loading arrow on the distal end of the Stapler Handle with the loading arrow on the proximal end of the Stapler Reload.
6. With the loading arrows aligned, insert the Stapler Reload over the pin extending from the distal end of the Stapler Handle.
7. Twist the Stapler Reload clockwise approximately 45° to lock into place.

NOTE: Remove the yellow/orange shipping wedge before closing the Stapler Reload jaws.

8. Remove the yellow/orange shipping wedge from the Stapler Reload before confirming proper loading and inserting the device into the trocar.
9. To confirm proper loading, squeeze the Stapler Handle trigger through a full stroke once to close the jaws. Retract the return pulls and confirm that the stapler jaws open fully.

## 2.2. UNLOADING INSTRUCTIONS

1. In order to unload the Stapler Reload from the Stapler Handle, the return pulls on the Stapler Handle must be fully retracted to the proximal position and the articulation handle must be centered on the device.
2. To unload the Stapler Reload, activate the unload button on the distal end of the Stapler Handle by sliding proximally.
3. While holding the unload button in the proximal position, rotate the Stapler Reload approximately 45° and pull distally until it disengages from the Stapler Handle.
4. Release the unload button.

## 2.3. USE INSTRUCTIONS

NOTE: Ensure that stapler reload jaws are closed prior to introducing the stapler into the trocar.

1. Squeeze the Stapler Handle trigger through a full stroke once to close the jaws before inserting into the trocar.
2. Insert the stapler into an appropriately sized trocar and open the stapler jaws by retracting the return pulls fully to the proximal position.

NOTE: The stapler anvil must be completely visible past the distal end of the trocar prior to opening the reload jaws within the body cavity.

NOTE: Do not squeeze the Stapler Handle trigger while retracting the return pulls.

The AEON™ Endoscopic Stapler Handle shaft can rotate 360° in either direction and can articulate the Stapler Reload jaws up to approximately 45° in either direction left-right using the articulation handle.

3. Apply the Stapler Reload jaws to the tissue to be transected. The device will not cut tissue beyond the cut line indicated on both sides of the jaws. More than one Stapler Reload application may be required for tissue exceeding the length of the staple line (30mm, 45mm, or 60mm). For Curved Tip Stapler Reloads, only clamp on structures that do not extend beyond the cut line.
4. Close the jaws of the device across the tissue to be transected by activating the Stapler Handle trigger through a full stroke. The jaws may be repositioned if necessary by retracting the return pulls proximally to open the jaws, repositioning, and squeezing the trigger to close the jaws.



**CAUTION:** If clamping is difficult, reposition the reload and clamp on less tissue. Ensure that the proper reload selection has been made.

**WARNING:** Inspect the tissue thickness before applying the stapler to the tissue. Tissue that is overly thick or thin may result in unacceptable staple formation.

**WARNING:** Clamping and unclamping of delicate structures, such as venous structure and bile ducts, may result in damage to tissue irrespective of stapler firing.

**WARNING:** The stapler will cut and staple any tissue, vessel, or other structure included in the jaws. Visually inspect prior to firing for inclusion of unintended anatomic structures within the staple line. Ensure that only structures to be cut and stapled are within the reload jaws. Unintentional transection of tissue could lead to patient injury, illness, or death.

**WARNING:** Ensure that no obstructions, such as clips, are incorporated into the stapler jaws before application. Applying staples over an obstruction may result in incomplete transection and/or incorrectly formed staples.

**WARNING:** Ensure tissue has not extended beyond the tissue stop proximally. Tissue forced into the instrument proximal to the tissue stop may be transected without stapling or result in stapler malfunction.

5. After closing the jaws across the tissue to be transected, the safety button must be activated by pressing from either side of the Stapler Handle before firing. Allow the tissue to adequately compress before firing ( approximately 15 seconds after clamping). Release the safety button.
6. After activating the safety button, the device is fired by pulling on the trigger to commence transecting the tissue while simultaneously forming staples. Squeeze the trigger sequentially until the Stapler Reload blade reaches the distal end of the jaws and the Stapler Handle locks. Stop squeezing the trigger when the distal end of the reload is reached and the trigger locks. The number of sequential squeezes is dependent upon the length of the Stapler Reload staple line (30mm, 45mm, or 60mm).

*If using Stapler Handle with "Standard/Thick" mode switch:*

- *The "Standard/Thick" mode switch on the side of the Stapler Handle allows the user to change the lever point of the handle trigger, which allows the device to be fired with less trigger force.*
- *The "Standard/Thick" mode switch can be activated after activating the safety button or at any position in the reload firing stroke.*
- *If the device is unclamped and re-positioned, the switch will reset to "Standard" mode and must be activated again.*
- *The switch will automatically reset to "Standard" mode after return pulls are retracted.*
- *NOTE: If the switch does not automatically reset after retraction, do not continue to use the handle as device malfunction may result.*
- *NOTE: Do not attempt to switch from "Thick" mode to "Standard" mode during device firing, as this can cause device malfunction.*

**WARNING:** Ensure that the Stapler Reload is completely fired. Failure to completely fire the Stapler Reload will result in an incomplete cut and/or incomplete staple formation, which may result in inadequate hemostasis and/or leakage. However, if an unusually high firing force is experienced mid-firing, consider stopping the firing and retracting the Stapler Reload. An unusually high firing force could indicate that the tissue is overly thick or that an obstruction is within the jaws. This may be indicated by a snap or pop sound in the handle.

NOTE: A tissue gap control mechanism in the stapler reload ensures the anvil and cartridge maintain the appropriate tissue gap while firing.

NOTE: A safety interlock prevents an empty Stapler Reload from being fired twice. Do not attempt to override the safety interlock, as overriding the safety interlock will cause device malfunction.











7. Once the device has been fully fired, open the jaws by retracting the return pulls completely back to the proximal position. Gently remove the device from the tissue and inspect the staple line for hemostasis.
8. After removing the device from the tissue, close the stapler jaws by squeezing once on the trigger through a complete stroke and center the articulation handle before removing the device from the body cavity.
9. Remove the device from the body cavity and unload the Stapler Reload.
10. Dispose of used instruments in accordance with the end-user's medical and biological waste disposal requirements.

NOTE: Ensure that the articulation handle is centered on the device before removing the stapler from the trocar.

**WARNING: After firing the stapler, always inspect the staple line and the surrounding site for hemostasis or leakage. Minor bleeding or leakage may be controlled by electrocautery or manual sutures.**

**CAUTION: Do not exceed 25 firings for a single Stapler Handle during a single procedure. Exceeding the Stapler Handle firing limit may result in device malfunction.**

## A. APPENDIX A: SYMBOLS REFERENCE TABLE

SYMBOL	MEANING
	Manufacturer
	Date of Manufacture
	Do not use if package is damaged
	Keep dry
	Consult Instructions for Use
	Store at room temperature. Avoid prolonged exposure to elevated temperatures.
	Do not re-use
	Do not re-sterilize
	Not made with natural rubber latex
	Federal law restricts this device to sale by or on the order of a physician.
	Sterilized using ethylene oxide

<b>SYMBOL</b>	<b>MEANING</b>
	Use by date